

Air Quality Monitoring: The Use of Arduino and Android

Ashish M. Husain ¹, Tazrin Hassan Rini ^{*2}, Mohammed Ikramul Haque ³
and Md. Rakibul Alam ⁴

In this paper a cost efficient, portable, easily manageable Arduino based device has been presented to monitor air quality. The device works by collecting data of quantity of specific harmful gases and the amount of dust present in the air. This device can be located at any place and the data can be transferred to an Android phone via Bluetooth or simply by connecting the device to a PC/laptop. Data collected by the device from different places can be later examined to make further decisions and analysis about the state of air quality; furthermore, it can also help concerned individuals to act upon it.

Field of Research: Environmental Engineering

1. Introduction

Air pollution can be defined as an atmospheric condition in which various substances are present at concentrations high enough, above their normal ambient levels to produce a measurable effect on people, animals, vegetation or materials (Bangladesh environment 2015). Air pollutants are dangerous to human health as well as environment too. If the concentrations of air pollutants increase, it can be fatal for this world and the living things on it. Air pollution contains quantum amounts of Carbon monoxide (CO), Sulfur dioxide (SO₂), Nitrogen oxides (NO_x), Ozone (O₃), Hydrocarbons (HC), lead (Pb) and Suspended Particulate Matter (SPM). These are some of the pollutants that have given rise to diseases and environmental catastrophes.

Air pollution is one of the major threats of recent times. Air quality monitoring is very important as it has a direct impact on human health and the environment. It has become an essential need to control air pollution to provide a safer future for the next generation. Indeed, the thought of attempting to lower the impacts of air pollution is of great stature, but before that, we must understand the pattern of the air pollution data. Data regarding air quality, toxins, dust etc. would not only help understand the aggravation of air pollution, but also identify places that are prone to health hazards. Human beings and natural activities cause air pollution. Natural events that pollute the air are forest fires, volcanic eruptions, wind erosion, evaporation of organic compounds and natural radioactivity. Human activities that cause air pollution include emissions from industries and manufacturing activities, burning fossil fuels,

^{a, b, c} BSc Student, Independent University, Bangladesh (IUB), Block-B, Bashundhara R/A, Dhaka-1229, Bangladesh, Email: ashish.m.husain@gmail.com, *htazrin@yahoo.com, haque.ikramul@gmail.com

^d Junior Lecturer of CSE Department, Independent University, Bangladesh (IUB), Block-B, Bashundhara R/A, Dhaka-1229, Bangladesh, Email: rakib@iub.edu.bd

Husain, Rini, Haque & Alam

vehicles, household and farming chemicals etc. The purpose of the device is to detect certain harmful air pollutants and log the amount at which they are present. The device outputs values in a predefined range when exposed to certain pollutants which will be discussed in more details later on. It can be used to monitor industrial air pollution, furthermore It can also be used in hospitals and sophisticated places where air pollution should be as less as possible. Examples include hospitals, Children's Nursery, baby carriages, schools etc. The data provided from the device can be used to distinguish between polluted and less polluted areas.

The severe problems that were mentioned earlier can indeed be monitored to help understand the delicate situation. To make this possible a compact device was constructed that can monitor air pollutants and harmful gases in the environment. The hardware of the device consists of three sensors which include Sharp's optical dust sensor GP2Y1010AU0F, gas sensors MQ-9, MQ-135 and a HC-05 Bluetooth module. These three sensors are connected with an Arduino. The device measures the pollutants in the air and generates real time data, which can either be seen in a computer or an android device using the Bluetooth module. There has been some research going on regarding air pollution but this paper differs from others because it deals with maximum air pollutants where others dealt with only few. This paper deals with Carbon Monoxide (CO), NH₃, NO_x, alcohol, Benzene, smoke, CO₂ and dust. This device can detect the pollutant which is harmful to human being as well as to environment.

Section 1 focuses on the 'Introduction'. The 'Literature Review' has been discussed in section 2. The 'Methodology' has been described in section 3. Then the whole system with the components and the results has been elaborately described in the 'Discussion' in section 4. Section 5 deals with the 'Comparison between the existing systems and the proposed system' with the price and air pollutants measured by each existing system with the proposed one.

2. Literature Review

Air Pollution has been one of the major issues of the world. Regarding this issue much research work has been conducted. The study of air pollution has been going on for many years. "Design and Implementation of Indoor Environmental Quality Monitoring System Based on ZigBee" (Liu et al., 2015) presents a wireless monitoring system which monitors environmental parameters like temperature and humidity. In another work called "Arduair: Air Quality Monitoring" (Chaudhry 2013) shows a low-cost and portable device which can be placed anywhere and the data can be plotted graphically in real time. In a journal known as "Monitoring of Green House Gases Using Wireless Sensor Networks with Arduino Board" (Vadlamudi and Bhrinda, 2015), they monitored the greenhouse gas leakage such as CO₂, NO₂, humidity and temperature from industries and the data collected by the co-ordinator is updated into the webpage available on the web server. A similar journal called "On-line Monitoring of Green House gases Storage and Leakage Using Wireless Sensor Network" (Reddy and Natarajan, 2015) also showed an on-line greenhouse gas monitoring system based on wireless sensor network is implemented using X-bee Digi modules and open source hardware platform Arduino.

A research paper known as "Wireless Measurement Node for Dust Sensor Integration" (Khadem et al., 2012) proposes the combination of two technologies by

Husain, Rini, Haque & Alam

integration of an optical interferometer dust sensor with a conventional sensor networking platform through a data acquisition module. In a journal named “Development of wireless sensor network system for LPG gas leakage detection system” (Mujawar et al., 2015) presents a gas leakage detection through Xbee, gas sensor, GSM shield and Arduino. Another journal known as “Android Application to Recommend Home Security Threats” (Kokate et al., 2014) proposes gas leakage, fire and short-circuits events that are detected by the sensors using Arduino and then the alert message is sent to the Android application. In the thesis named “Development of Wireless Sensor Network System for Indoor Air Quality Monitoring” (Borkar 2012) showed air quality monitoring through different sensors, ZigBee and Arduino but the system is only for indoor. In another thesis named “Wireless Gas Monitoring System Of Gas Detector” (Hamdon 2012) proposed a project to develop data monitoring of alarm system for gas detector which uses MQ3, MQ9, LEDs, buzzer, exhaust fan and Zigbee.

In a journal named “ARDUEMISSION: Vehicular Emissions Monitoring” (Chaudhry 2014) presented electronic sensor based system using Arduino for monitoring the vehicular emissions which shows the technique for using and calibrating the device has been elucidated and various vehicles are then examined using this device for their emissions of Carbon Monoxide gas in the atmosphere. ‘WSN for AIR Quality Monitoring in Annaba City’ (2015) shows a WSN architecture where nodes are equipped with gas, temperature and dust sensors and Arduino Uno as microcontroller have been designed for air quality monitoring for some sensible area in Annaba City East of Algeria.

3. Methodology

The proposed device consists of three sensors that were used to monitor the air quality. MQ-9 and MQ-135 are amongst the gas sensors and optical dust sensor GP2Y1010AU0F was used to identify the concentration of dust particles in the air. The sensors are connected to Arduino Mega 2560 board and when the Arduino is powered on, the sensors start to generate data continuously in real time. The data can also be transferred to an Android phone using Bluetooth communication with the device or a computer using the COM port. For transferring data to an Android device, the user would simply have to connect to our device using the Android phone’s Bluetooth interface and by using our custom android application to transfer data. The data mainly consists of air pollutant intensity values. Higher values indicate higher air pollutants and vice versa. The block diagram of the whole system is shown below in Figure 1.

Figure 1: Block Diagram of the Proposed System

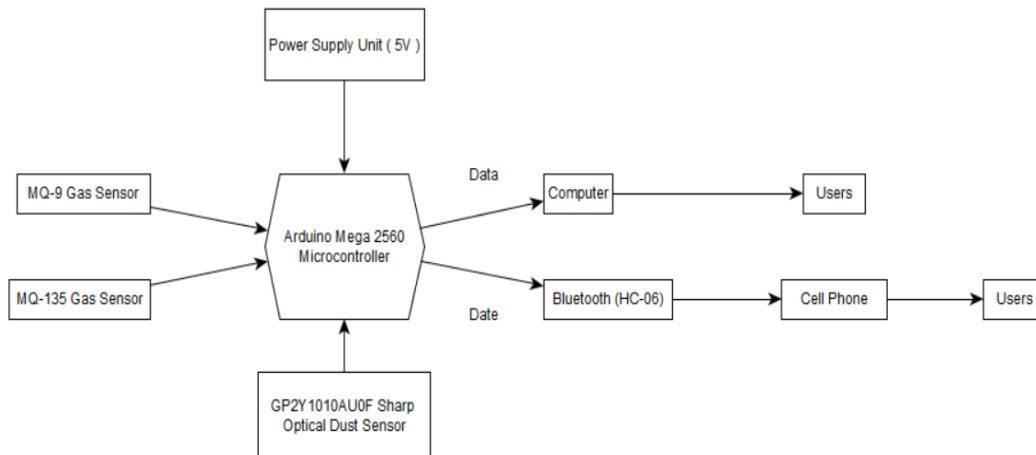

The purpose of using Arduino and Android is that now-a-days, they are very much accessible and cheap as well. Any person can have it within the budget. And the sensors that have been used here are very much handy and replaceable too. Moreover, the reason behind using the all the components are that they are user friendly and can be used and understood by any age of people.

4. Discussion

4.1 Hardware Components Used in the Proposed System

The hardware of the device consists of three sensors which include Sharp's optical dust sensor GP2Y1010AU0F, MQ-9, MQ-135, HC-05 Bluetooth module and an Arduino Mega board. The device measures the pollutants in the air and generates real time data, which can either be seen on a computer or an Android device using the Bluetooth module.

4.1.1 Arduino Mega 2560 Microcontroller:

Arduino is the perfect microcontroller due to its high performance and special features. The ATmega2560 AVR (Arduino 2015) comes with an entire set of program and system development tools including macro assemblers, C compilers, in-circuit emulators, program debugger /simulators and evaluation kits. It has 54 digital input/output pins (of which 15 can be utilized as PWM outputs), 16 analog inputs, 4 UARTs (hardware serial ports), a 16 MHz crystal oscillator, a USB connection, a power jack, an ICSP header, and a reset button. The ATmega2560 was chosen for the proposed system design due to its low cost with full efficiency and excellent interfacing capability with air quality sensors such as MQ-9, MQ-135 and GP2Y1010AU0F Sharp Optical Dust Sensor. The picture of Arduino Mega 2560 is shown in Figure 2.

Figure 2: Arduino Mega 2560 Front & Back Side



4.1.2 MQ-9 Gas Sensor:

MQ-9 gas sensor (Seeedstudio 2015) has high sensitivity to Carbon Monoxide (CO). The sensor has high sensitivity to CO and ignitable gases; it has low cost and is suitable for different applications such as Industrial/Portable gas detection. The delicate material utilized as a part of the MQ-9 gas sensor is tin dioxide (SnO_2), which has lower conductivity in a clean air medium. At the point when the target CO is detected, the sensor's conductivity rises and increments proportionately as the degree of CO gas increases. The MQ-9 gas sensor was chosen for a high performance detection range (i.e.) 10-1000ppm for (CO), 100-10000ppm for ignitable gas, which has got its quick reaction time and is a low controlled powered device (<5V) [3]. This sensor has diverse resistance esteem in distinctive concentration. The picture of MQ-9 Gas Sensor is shown in Figure 3.

Figure 3: MQ-9 Gas Sensor Front & Back Side

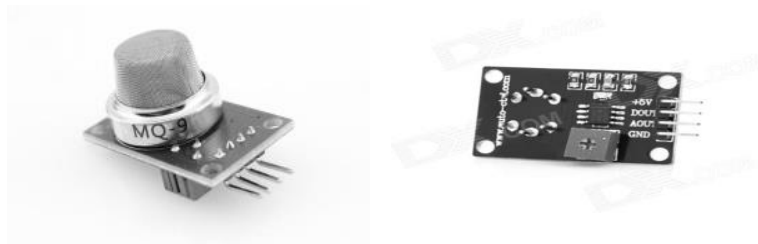

4.1.3 MQ-135 Gas Sensor:

MQ-135 gas sensor (Waveshare 2015) has high sensitivity to detect different types of gases. They are used in air quality control equipment's for buildings/offices, are suitable for detecting of NH_3 , NO_x , alcohol, Benzene, smoke, CO_2 , etc. The delicate material used in MQ-135 gas sensor is tin dioxide (SnO_2), which has lower conductivity in a clean air medium. At the point when the target gas is detected, the sensor's conductivity rises and increments proportionately as the extent of gas increase. The MQ-135 gas sensor was chosen for a high performance detection range (i.e.) 10ppm-300ppm NH_3 , 10ppm-1000ppm Benzene, 10ppm-300ppm Alcohol which has got its fast response time and is a low powered device (<5V) [4]. This sensor has different resistance value in different concentration. The picture of MQ-135 Gas Sensor is shown in Figure 4.

Figure 4: MQ-135 Gas Sensor Front & Back Side

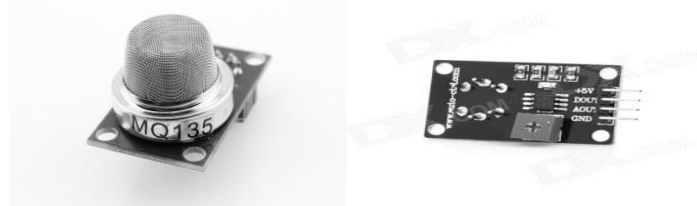

4.1.4 GP2Y1010AU0F Sharp Optical Dust Sensor:

GP2Y1010AU0F Sharp Optical Dust sensor which is a minimal, ease optical dust sensor, comprising of an infrared emanating diode and a phototransistor, was utilized as air quality sensor as a part of the system. It identifies airborne particles utilizing scattered light and is equipped for recognizing fine particles. It is normally utilized as a part of air purifiers and air screens. The sensor has very low current consumption (20mA max, 11mA typical) and can be powered with up to 7VDC. The output of the sensor is an analog voltage proportional to the measured dust density, with a sensitivity of 0.5V/0.1mg/m³ (Sparkfun 2015). The sensor was chosen because of its compact size, envisioned for integration in air purifiers or air conditioning units which is also suitable for our design. The picture of GP2Y1010AU0F Sharp Optical Dust Sensor is shown in Figure 5.

Figure 5: GP2Y1010AU0F Sharp Optical Dust Sensor



4.1.5 Bluetooth (HC-06):

Bluetooth serial module is used for converting serial port for Bluetooth. It uses the UART protocol to make it easy to send and receive data wirelessly. This module is a slave only device which means that it can connect to most phones and computers with Bluetooth but it cannot connect to other slave only devices such as keyboards and other HC-06 modules. The input voltage range is 3.3V to 6V. HC-06 Bluetooth module was adopted for wireless communication with a range of up to 30 feet. Bluetooth has been perceived as a viable mode for short range data communication due to the fact that it has moderately low power utilization and ease compared with Wi-Fi or GSM information/data transmission (Piguino-Wiki 2015). The picture of Bluetooth HC-06 is shown in Figure 6.

Figure 6: Bluetooth (HC-06)

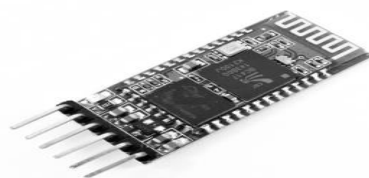

4.2 Prototype of the Proposed System

When the Arduino is powered on by 5volt battery or a USB power supply, the entire system will become functional. Each sensor of the device produces their individual reading. Each sensor has been calibrated according to our needs and the users can change the calibration at any time in order to receive output values according to their specific requirements. The hardware design of the proposed system is shown in Figure 7.

Figure 7: Prototype of the Proposed System

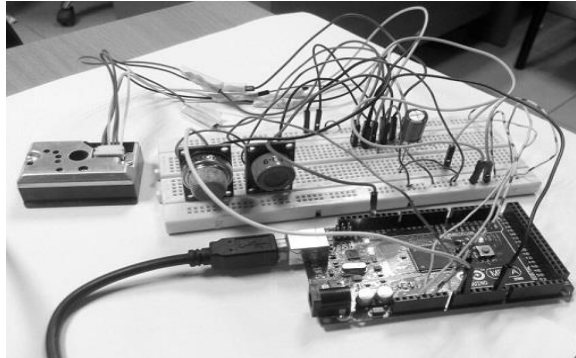

The MQ-9 gas sensor when subjected to the carbon monoxide produces output in the form of voltages that can be calibrated according to real world scenarios. It has a variable resistor on its body which can be used to calibrate the output voltage of the device. According to our scenario higher readings in the range (1-1000) tend to indicate higher levels of carbon monoxide. The MQ-135 gas sensor when subjected to NH₃, NO_x, alcohol, Benzene, smoke, CO₂ produces output in the form of voltage. We have scaled it to our requirements where the readings are between 0 to 5, where values closer to 0 indicates better air quality and higher values indicates worse air quality. The GP2Y1010AU0F Sharp Dust sensor has a similar functionality as it also produces voltage values when subjected to dust in the air. It also produces values among the range (1-1000) where the values closer to 1000 indicate a dustier condition. The general purpose of the Bluetooth module, known as the HC-06 is to transfer data from the device to the Android phone or any Bluetooth terminal device. This makes it convenient to transfer data between two different Bluetooth enabled devices.

4.3 Android Application of the Proposed System

In order to make the data collection process more convenient, we opted to choose the Android mobile platform because of its popularity and productiveness. To collect the data from the device to phone an Android application was built using the Android SDK (Developer. Android 2015). The application will run on android phones with a minimum requirement of the operating system Ice Cream Sandwich. The Application functions by making the user pair the phone with the physical air quality measuring device via Bluetooth. After successfully establishing a connection, the user is prompted to load the data to their phone. This process retrieves the data from the air measuring device to the Android phone using the Bluetooth. The data later can be saved on to the physical memory/SD Card of the phone.

4.4 Results

The air analyzer device requires 5volt input voltage to function. The voltage source can be a USB powered brick or a battery pack that can deliver the functioning voltage. The device is plugged with MQ-135, MQ-9, Optical Dust sensor and a Bluetooth module. All the individual components function distinctively and produce their own outputs. The entire device works as a perfect data logging unit that can keep a log of the level of dust, carbon mono-oxide and NH₃, NO_x, alcohol, Benzene, smoke, CO₂ in an environment. Once the device is powered on, the sensors will be

Husain, Rini, Haque & Alam

turned on and will start generating data which will be sent to two mediums, the com-port and the Bluetooth module. Sending it to two different mediums is done so that the end user can witness data either in their Android phone or the computer that they are working on. The output seen from a computer screen and Android phone is shown below in Figure 8 & 9.

Figure 8: Sample Output Seen on Computer Screen

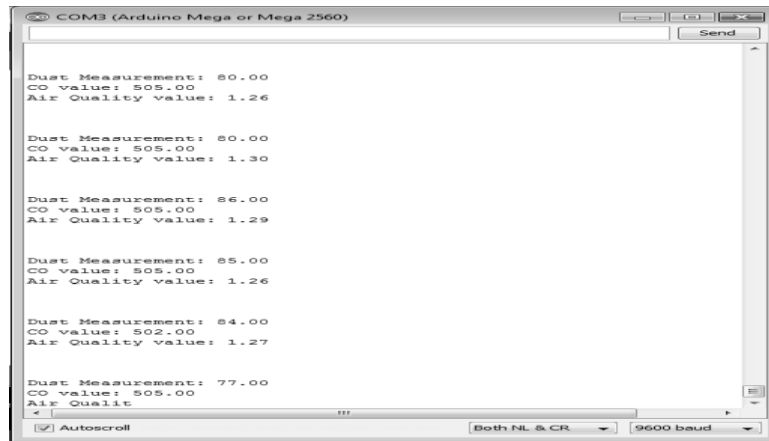
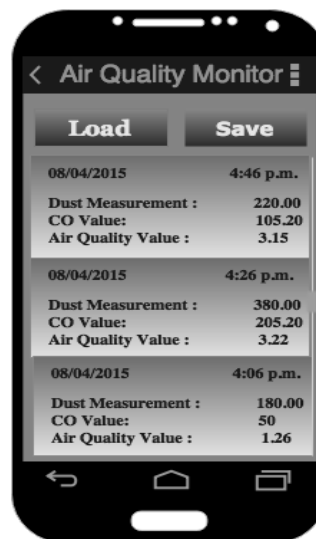

Figure 9: Sample Output Seen on Android Application



The device can be placed anywhere and data can be taken from anywhere within the Bluetooth's range. We opted to provide further convenience to the users of the device by developing the Android application which will receive the data from the device when connected. Figure 9 shows data being sent to the serial monitor of a computer having an Arduino development environment.

This device is affordable and easy to use. There may be many air monitoring devices available in the market, but they may be quite expensive. The proposed device is cheaper and more user friendly. The cost of this device has been listed below in Table 1.

Table 1: Price List of the Components Used in the Proposed System

Item No.	Device	Quantity	Cost (\$)
1.	Arduino Mega 2560	1	6.20
2.	MQ-9 Gas Sensor	1	2.10
3.	MQ-135 Gas Sensor	1	1.94
4.	GP2Y1010AU0F Sharp Optical Dust Sensor	1	4.09
5.	Bluetooth (HC-06)	1	2.95
6.	5-Volt Power Source	1	14.95
7.	Enclosure/Chassis	1	15.00
			Total : 47.23 USD

As it can be seen from the above table, the price of each component is quite cheap and affordable for everyone. This is the minimum cost of the proposed system and maximum cost will never be more than 100 USD even if the system has more sensors or it has a fancy look.

5. Comparison between the Existing Systems and the Proposed System

There are some existing systems which monitor the Air Pollution, but the proposed system has many advantages over them. It can be seen from Table 2 that the existing system might be much more sophisticated from the proposed system, both in terms of price and monitoring air pollutants, the proposed system excels but at a lesser cost. Our proposed device is modular. If any of the sensors malfunctions, they can be easily replaced without having to replace the entire device.

Table 2: Comparison between the Existing Systems and the Proposed System

<u>Device Name</u>	<u>Air Pollutants measured by the device</u>	<u>Price</u>
Indoor Air Quality Meter - CO ₂ , Temperature & Relative Humidity	CO ₂ , Temperature & Relative Humidity	\$129.00
Mini CO ₂ Monitor	CO ₂	\$109.00
PYLPCMM05 - PYLE PCMM05 Carbon Monoxide Meter	Carbon Monoxide (CO)	\$227.24
The proposed system	Carbon Monoxide (CO), NH ₃ , NO _x , alcohol, Benzene, smoke, CO ₂ , Dust	\$ 47.23

Husain, Rini, Haque & Alam

The above table shows how the proposed system excels from others readymade products. Among the existing systems, the proposed one is cheaper, modular by design and can be extendable to changes readily.

6. Conclusion

In this paper, a low cost and portable system has been designed which can give real time data of air pollutants and save it also to monitor air quality. The system has Arduino which has the control to access all the sensors. Then Bluetooth module has been used so that the sensors can send data to Android Phone via Bluetooth. The device can be placed anywhere and data can be taken from anywhere within the Bluetooth's range. Data reading from the sensors has been successfully transferred to COM Port and Android phone via Bluetooth from Arduino and it can be monitored easily so the objective of the project was successful. The proposed device can be used to monitor air quality in many aspects. It can be used in industry, hospital, streets and many other places for daily monitoring. It's a compact device to monitor air quality from any place as the system is modular and portable. Furthermore, its modest power requirements and reasonable build cost make it an ideal device for mass deployment. This device can be used for further research on air pollution due to its ability to transfer and store data logs which would help make decisive decisions and strong mathematical models. Analysis of data produced from the device would raise awareness. Decisions regarding safety can be taken once enough data is present to support the cause. It has been already stated that it is a compact device that can measure maximum number of pollutants than other devices which researchers have previously done. The device is affordable too than other devices. The whole system is new as it is not only confined into the hardware, the system also has the software part. The data is stored and also can be seen through Android application easily from anywhere.

In future, the device can be placed in various places of Dhaka city for a long period of time to get big data from this and by this, a pattern can be designed and by using the pattern we can predict about the air pollution in near future as well. From data comes research and humans can only act upon a situation when enough data and research is present and this is where our device will come into play.

There are a few limitations to this idea involving the accuracy of the data produced by the sensors, placement of the device to get the most optimal readings and minimize error. Furthermore, the concept of air quality monitoring has a lot of variables. There are many harmful gases, pollutants that have not been accounted for in this proposal but as our device is modular, better sensors and additional components can be installed to further take into account other harmful gases or pollutants which we couldn't address with our present predicament.

References

- Arduino 2015, Products, Arduino Board Mega 2560, viewed 28 July, 2015, <<https://www.arduino.cc/en/Main/ArduinoBoardMega2560>>
- Bangladeshenvironment 2015, Pollution's, Air Pollution, Air Pollution in Dhaka City, viewed 28 July, 2015, <<http://www.bangladeshenvironment.com/index.php/polution-s/air-polution/291-air-pollution-in-dhaka-city>>

Husain, Rini, Haque & Alam

- Borkar, C 2012, 'Development of Wireless Sensor Network System for Indoor Air Quality Monitoring', Master of Science, University of North Texas.
- Chaudhry, V 2013, 'Arduair: Air Quality Monitoring', *International Journal of Environmental Engineering and Management*, Volume 4, Number 6, pp.639-646.
- Chaudhry, V 2014, 'ARDUEMISSION: Vehicular Emissions Monitoring', *International Journal of Advanced Research in Engineering and Applied Sciences*, Volume 3, Number 7, pp.35-44.
- Developer.Android 2015, Develop, Tools, viewed 27 October, 2015, <<https://developer.android.com/sdk/index.html>>
- Fezari, M, Boumazai, MS, Al-Dahoud, A and Al-Dahoud, A 2015, 'WSN for AIR Quality Monitoring in Annaba City', *ICIT 2015 The 7th International Conference on Information Technology*, pp. 283–288.
- Hamdon, ZB 2012, 'Wireless Gas Monitoring System of Gas Detector, Bachelor of Engineering (Electrical – Medical Electronics), Universiti Teknologi Malaysia.
- Kalic, G, Bojic, I and Kusek, M 2012, 'Energy consumption in android phones when using wireless communication technologies', *MIPRO, 2012 Proceedings of the 35th International Convention*, pp. 754–759.
- Khadem, MI, Stamatescu, G and Sgarciu, V 2012, 'Wireless Measurement Node for Dust Sensor Integration', *SENSORCOMM 2012: The Sixth International Conference on Sensor Technologies and Applications*, pp.159-164.
- Kokate, SR, Jadhav, P, Bankhele, T, Nikalje, P and Chintawar. P 2014, 'Android Application to Recommend Home Security Threats' , *International Journal of Engineering Technology and Management (IJETM)*, Volume 2, Issue 2, pp. 86-89.
- Liu, XM, Wang FF and Zeng, ZB 2015, 'Design and Implementation of Indoor Environmental Quality Monitoring System Based on ZigBee', *International Conference on Computer Information Systems and Industrial Applications (CISIA 2015)*, pp. 297- 300.
- Mujawar, TH, Bachuwar, VD, Kasbe, MS, Shaligram, AD and Deshmukh, LP 2015, 'Development of wireless sensor network system for LPG gas leakage detection system', *International Journal of Scientific & Engineering Research*, Volume 6, Issue 4, pp. 558-563.
- Piguino-Wiki 2015, SPP Bluetooth Modules, viewed 28 July, 2015, <http://wiki.pinguino.cc/index.php/SPP_Bluetooth_Modules>
- Reddy, MA and Natarajan, V 2015, 'On-line Monitoring of Green House gases Storage and Leakage Using Wireless Sensor Network', *International Research Journal of Engineering and Technology (IRJET)*, Volume: 02, Issue: 01, pp.158-161.
- Seedstudio 2015, Wiki, Grove - Gas Sensor, viewed 28 July, 2015, <http://www.seeedstudio.com/wiki/Grove_-_Gas_Sensor>
- Sparkfun 2015, Products, Optical Dust Sensor-GP2Y1010AU0F, viewed 28 July, 2015, <<https://www.sparkfun.com/products/9689>>
- Vadlamudi, MK and Brindha, GS 2015, 'Monitoring Of Green House Gases Using Wireless Sensor Networks with Arduino Board', *International Journal of Science, Engineering and Technology Research (IJSETR)*, Volume 4, Issue 4, pp. 741-745.
- Waveshare 2015, Wiki, MQ-135 Gas Sensor, viewed 28 July, 2015, <http://www.waveshare.com/wiki/MQ-135_Gas_Sensor>